

Zubehör/Ersatzteile für Zwischenhülsen

Accessories/Spare parts for adaptor sleeves

Accessoires/Pièces de rechange pour réductions

Zwischenhülsen für Zylinderschäfte

Adaptor sleeves for parallel shanks

Réduction pour queues cylindriques

DIN 1835 B

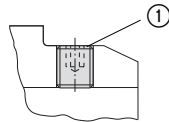
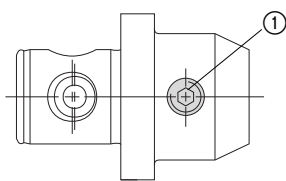

DIN 1835 E

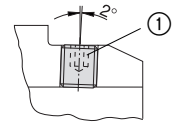
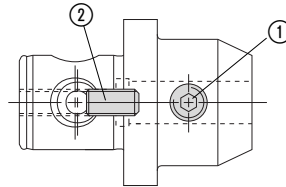

Spanndurchmesser Clamping diameter Diamètre de serrage	Gewindestift ① Thread pin Goupille filetée Best.-Nr. Order No. No de cde.	Schlüssel Key Clé	Gewindestift ② Thread pin Goupille filetée Best.-Nr. Order No. No de cde	Schlüssel Key Clé	Gewinde Thread Taraud
6	115 680	s3 / B	415 562	s2,5 / B	M 5
8	115 681	s4 / B	215 863	s3 / B	M 6
10	115 682	s5 / B	215 863	s3 / B	M 6
12	115 683	s6 / B	415 563	s4 / B	M 8
14	115 683	s6 / B	415 563	s4 / B	M 8
16	115 684	s6 / B	215 849	s5 / B	M 10
18	115 684	s6 / B	215 849	s5 / B	M 10
20	115 685	s8 / B	215 849	s5 / B	M 10
20	115 685	s8 / B	215 865	s8 / B	M 16
25	115 686	s10 / B	215 527	s5 / B	M 10
25	115 686	s10 / B	215 865	s8 / B	M 16
32	115 687	s10 / B	215 527	s5 / B	M 10
32	115 687	s10 / B	215 865	s8 / B	M 16
40	115 687	s10 / B	215 527	s5 / B	M 10
40	115 687	s10 / B	215 865	s8 / B	M 16



H

Zubehör/Ersatzteile für Zwischenhülsen

Accessories/Spare parts for adaptor sleeves

Accessoires/Pièces de rechange pour réduction

**Spannhülsen für Gewindebohrer
passend in Zwischenhülsen mit
Aufnahmen nach DIN 1835 B**

*Adaptor sleeves for tap shanks
suitable for reduction sleeves*

*Douilles de serrage adaptables aux
réductions*

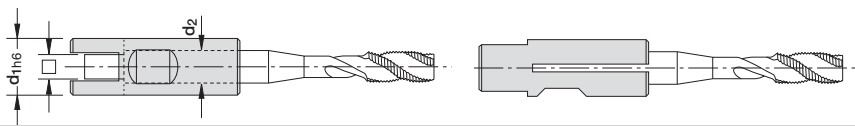

$d_{1\ h6}$	$d_2 \times \square$	Best.-Nr. Order No. No de cde.	$d_{1\ h6}$	$d_2 \times \square$	Best.-Nr. Order No. No de cde.	$d_{1\ h6}$	$d_2 \times \square$	Best.-Nr. Order No. No de cde.
8	2,5 - 2,1	271 190	16	9,0 - 7,0	271 198	32	22,0 -18,0	271 206
8	2,8 - 2,1	271 191	16	10,0 - 8,0	271 199	40	25,0 -20,0	271 207
10	3,5 - 2,7	271 192	18	11,0 - 9,0	271 200	40	28,0 -22,0	271 208
10	4,0 - 3,0	271 193	20	12,0 - 9,0	271 201	50	32,0 -24,0	271 209
10	4,5 - 3,4	271 194	25	14,0 -11,0	271 202	50	36,0 -29,0	271 210
12	6,0 - 4,9	271 195	25	16,0 -12,0	271 203	50	40,0 -32,0	271 211
14	7,0 - 5,5	271 196	32	18,0 -14,5	271 204	-	-	-
14	8,0 - 6,2	271 197	32	20,0 -16,0	271 205	-	-	-

**Micro-Spannfutter passend in
Zwischenhülsen mit Aufnahmen
nach DIN 1835 B**

*Micro clamping chucks suitable for
reduction sleeves*

*Micro-mandrins adaptables aux
réductions*

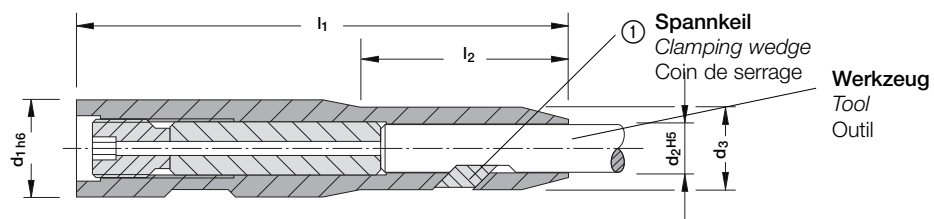

Größe Size Dimension	$d_{1\ h6}$	d_2^{H5}	d_3	l_1	l_2	Best.-Nr. ① Order No. No de cde.	Best.-Nr. Order No. No de cde.
16	16	6	12	100	40	219 170	219 070
16	16	8	14	100	45	219 171	219 071
20	20	10	17	100	43	219 172	219 072
25	25	12	20	110	39	219 173	219 073
25	25	14	22	110	46	219 174	219 074
32	32	16	25	125	45	219 174	219 075
32	32	18	27	130	54	219 174	219 076
32	32	20	30	130	62	219 175	219 077

Die Spannfutter sind zur Aufnahme von Werkzeugen mit Zylinderschaft nach DIN 1835-B geeignet und werden in Zwischenhülsen mit seitlicher Befestigung eingesetzt (Bild 1). Durch die schlanke Bauweise können Bearbeitungen mit Standardwerkzeugen durchgeführt werden, bei denen sonst teure Sonderwerkzeuge erforderlich sind (Bild 2).

The clamping chucks are used in reduction sleeves for the clamping of tools with cylindrical shanks to DIN 1835-B (Fig. 1). The chucks' slimline design makes it possible to use standard tools instead of otherwise expensive special tools (Fig. 2).

Le micro-mandrin est monté dans la réduction conçue pour le serrage d'outils avec plat selon DIN 1835-B (Fig. 1). La forme de construction permet l'utilisation d'outils standards en lieu et place d'outils spéciaux, toujours onéreux (Fig. 2).



Bild 1
Fig. 1
Fig. 1



Bild 2
Fig. 2
Fig. 2

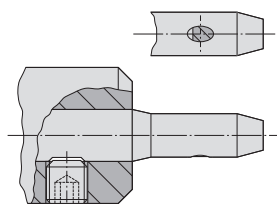

Zubehör/Ersatzteile für Bohrfutter

Accessories/Spare parts for drill chucks

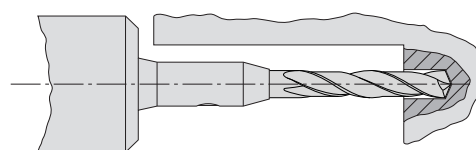
Accessoires/Pièces de rechange pour mandrins de perçage

Bedienschlüssel für Bohrfutter

Service keys for drill chucks

Clés de service pour mandrins de perçage

Schlüsselweite <i>Key size</i> Dim. de la clé	Type	Anziehdrehmoment <i>Tightening torque</i> Couple de serrage	Best.-Nr. <i>Order No.</i> No de cde.
		Nm	
2,5	B	15	415 577
6,0	B	15	115 578

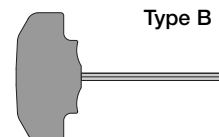

Montagewerkzeug für Dichtscheiben

Assembly tool for gasket

Outil de montage pour les rondelles d'étanchéité

Best.-Nr. <i>Order No.</i> No de cde.
387 112

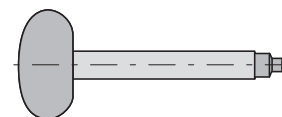

Dichtscheiben

Gaskets

Rondelles d'étanchéité

Dichtscheiben <i>Gaskets</i> Rondelles d'étanchéité	Spanndurchmesser <i>Clamping diameter</i> Diamètre de serrage	Best.-Nr. <i>Order No.</i> No de cde.
Ø mm	mm	
Ø 3 - 6	0,5 - 13	387 113
Ø 6 - 13	0,5 - 13	387 114
Ø 3 - 6	2,5 - 16	387 115
Ø 6 - 16	2,5 - 16	387 116



H

Zubehör/Ersatzteile für Spannzangenfutter

Accessories/Spare parts for collet chucks

Accessoires/Pièces de rechange pour mandrins porte-pinces

Spannzangenfutter für
Spannzangen System Erickson

Collet chucks for collets system
Erickson

Mandrins porte-pinces type
Erickson

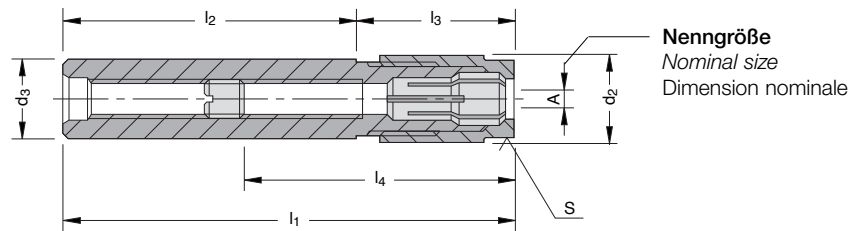

Größe Size Dimension	Nenngröße Nominal size Dimension nominale	Spannbereich Clamping range Capacité de serrage							Schlüsselweite Key size Dim. de la clé		Best.-Nr. Order No. No de cde.
d_3		A	d_2	l_1	l_2	l_3	l_4 min. max.		s	kg	
12,5	6	1 - 6,5	14	112	76	36	38	100	13	0,2	162 080
12,5	6	1 - 6,5	14	176	140	36	38	162	13	0,2	162 081
20,0	10	1 - 10	21	120	76	44	40	103	19	0,3	162 082
20,0	10	1 - 10	21	184	140	44	40	167	19	0,3	162 083

Zylindrische Spannzangenfutter
„Mini“, 8° für Spannzangen
DIN 6499

Cylindrical collet chucks,
8° for Collets DIN 6499

Mandrins porte-pinces cylindriques
8° pour Pincettes type DIN 6499

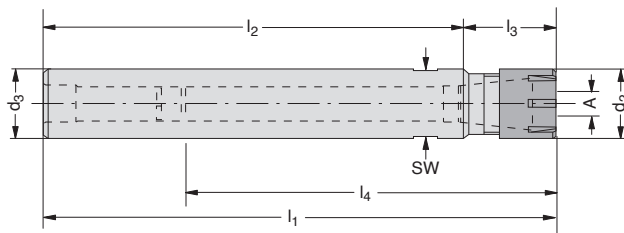

Größe Size Dimension nominale	Nenngröße Nominal size Dimension nominale	Spannbereich Clamping range Capacité de serrage							Schlüsselweite Key size Dim. de la clé		Best.-Nr. Order No. No de cde.
d_3		A	l_1	l_2	l_3	l_4 min. max.		d_2	SW		
8,0	ER 8	1 - 5	126,0	100,0	26,0	36,5	36,5	12,0	09	209 054	
12,0	ER 8	1 - 5	166,0	140,0	26,0	36,5	36,5	12,0	09	209 055	
16,0	ER 11	1 - 7	106,5	80,0	26,5	23	65	16,0	11	209 056	
16,0	ER 11	1 - 7	166,5	140,0	26,5	23	65	16,0	11	209 057	
20,0	ER 16	1 - 10	118,5	80,0	38,5	33	102	22,0	17	209 058	
20,0	ER 16	1 - 10	178,5	140,0	38,5	33	123	22,0	17	209 059	

Bedienschlüssel H 10.22

Service keys H 10.22

Clés de service H 10.22



Zubehör/Ersatzteile für Spannzangenfutter

Accessories/Spare parts for collet chucks

Accessoires/Pièces de rechange pour mandrins porte-pinces

Spannzangen für Spannzangenfutter System Erickson

Collets for collet chucks system Erickson

Pinces pour mandrins type Erickson

Nenngröße Nominal size Dimension nominale	Einheits- Nummer Standard-No. No standard	Spannbereich Clamping range Capacité de serrage			Satz / Set / Jeu Best.-Nr. Order No. No de cde.	
		d ₁	d ₂	l ₁	A	
6	416 E	9,5	7,62	25,5	0,5 - 6	071 016
10	417 E	13,5	11,43	30,4	0,5 - 10	071 017

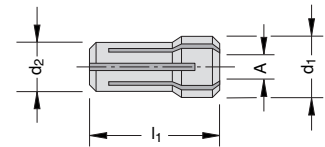

Nenngröße Nominal size Dimension nominale	Ø A von / bis from / to de / à	Best.-Nr. Order No. No de cde.	Ø A von / bis from / to de / à	Best.-Nr. Order No. No de cde.	Ø A von / bis from / to de / à	Best.-Nr. Order No. No de cde.	Ø A von / bis from / to de / à	Best.-Nr. Order No. No de cde.
6	1,0 - 0,5	071 355	2,5 - 2,0	071 358	4,0 - 3,5	071 361	5,5 - 5,0	071 364
6	1,5 - 1,0	071 356	3,0 - 2,5	071 359	4,5 - 4,0	071 362	6,0 - 5,5	071 365
6	2,0 - 1,5	071 357	3,5 - 3,0	071 360	5,0 - 4,5	071 363	-	-
10	1,0 - 0,5	071 368	3,5 - 3,0	071 373	6,0 - 5,5	071 378	8,5 - 8,0	071 383
10	1,5 - 1,0	071 369	4,0 - 3,5	071 374	6,5 - 6,0	071 379	9,0 - 8,5	071 384
10	2,0 - 1,5	071 370	4,5 - 4,0	071 375	7,0 - 6,5	071 380	9,5 - 9,0	071 385
10	2,5 - 2,0	071 371	5,0 - 4,5	071 376	7,5 - 7,0	071 381	10,0 - 9,5	071 681
10	3,0 - 2,5	071 372	5,5 - 5,0	071 377	8,0 - 7,5	071 382	-	-



H

Spannmuttern für Spannzangenfutter
ab Seite H 10.13.

Clamping nuts for collet chucks,
from page H 10.13.

Ècrous pour mandrins:
voir accessoires, page H 10.13.

Zubehör/Ersatzteile für Spannzangenfutter

Accessories/Spare parts for collet chucks

Accessoires/Pièces de rechange pour mandrins porte-pinces

Spannzangen DIN 6388-A 1:10

Collets DIN 6388-A 1:10

Pinces type DIN 6388-A 1:10

Nenngröße Nominal size Dimension nominale	Einheits- Nummer Standard-No. No standard	Spannbereich Clamping range Capacité de serrage		Satz / Set / Jeu Best.-Nr. Order No. No de cde.
	d_1	l_1	A*	
A 16	410 E	22,65	40	2 - 16 071 003
A 25	444 E	32,90	52	2 - 25 071 004
A 32	450 E	41,30	60	4 - 32 071 019

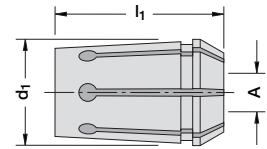

* für Schafttoleranz h_{10}

* for shank tolerance h_{10}

* pour tolérance du cône h_{10}

Nenngröße Nominal size Dimension nominale	Best.-Nr. Order No. No de cde.	Best.-Nr. Order No. No de cde.	Best.-Nr. Order No. No de cde.	Best.-Nr. Order No. No de cde.
$\emptyset A$	$\emptyset A$	$\emptyset A$	$\emptyset A$	$\emptyset A$
A 16	2,0	071 140	6,0	071 148
A 16	2,5	071 141	6,5	071 149
A 16	3,0	071 142	7,0	071 150
A 16	3,5	071 143	7,5	071 151
A 16	4,0	071 144	8,0	071 152
A 16	4,5	071 145	8,5	071 153
A 16	5,0	071 146	9,0	071 154
A 16	5,5	071 147	9,5	071 155
A 25	2,0	071 169	8,0	071 175
A 25	3,0	071 170	9,0	071 176
A 25	4,0	071 171	10,0	071 177
A 25	5,0	071 172	11,0	071 178
A 25	6,0	071 173	12,0	071 179
A 25	7,0	071 174	13,0	071 180
A 32	4,0	071 612	12,0	071 423
A 32	5,0	071 419	13,0	071 667
A 32	6,0	071 420	14,0	071 668
A 32	7,0	071 613	15,0	071 669
A 32	8,0	071 421	16,0	071 424
A 32	9,0	071 614	17,0	071 670
A 32	10,0	071 422	18,0	071 665
A 32	11,0	071 666	19,0	071 671



Spannmuttern für Spannzangenfutter
ab Seite H 10.13.

Clamping nuts for collet chucks,
from page H 10.13.

Écrous pour mandrins:
voir accessoires, page H 10.13.

Zubehör/Ersatzteile für Spannzangenfutter

Accessories/Spare parts for collet chucks

Accessoires/Pièces de rechange pour mandrins porte-pinces

Spannzangen DIN 6388-B 1:10

Collets DIN 6388-B 1:10

Pinces type DIN 6388-B 1:10

Nenngröße Nominal size Dimension nominale	Einheits- Nummer Standard-No. No standard	d_1	l_1	Spannbereich Clamping range Capacité de serrage A	Satz / Set / Jeu Best.-Nr. Order No. No de cde.
B 16	415 E	22,65	40	1,5 - 16	071 005
B 25	462 E	32,90	52	3,5 - 25	071 006
B 32	467 E	41,30	60	5,5 - 32	071 022

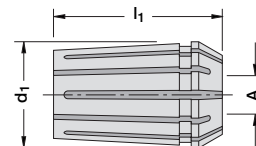

Nenngröße Nominal size Dimension nominale	Ø A von / bis from / to de / à	Bestell- Nummer Order No. No de cde.	Ø A von / bis from / to de / à	Bestell- Nummer Order No. No de cde.	Ø A von / bis from / to de / à	Bestell- Nummer Order No. No de cde.	Ø A von / bis from / to de / à	Bestell- Nummer Order No. No de cde.
B 16	2,0 - 1,5	071 625	6,0 - 5,5	071 197	10,0 - 9,5	071 205	14,0 - 13,5	071 213
B 16	2,5 - 2,0	071 626	6,5 - 6,0	071 198	10,5 - 10,0	071 206	14,5 - 14,0	071 214
B 16	3,0 - 2,5	071 621	7,0 - 6,5	071 199	11,0 - 10,5	071 207	15,0 - 14,5	071 215
B 16	3,5 - 3,0	071 622	7,5 - 7,0	071 200	11,5 - 11,0	071 208	15,5 - 15,0	071 216
B 16	4,0 - 3,5	071 193	8,0 - 7,5	071 201	12,0 - 11,5	071 209	16,0 - 15,5	071 217
B 16	4,5 - 4,0	071 194	8,5 - 8,0	071 202	12,5 - 12,0	071 210	-	-
B 16	5,0 - 4,5	071 195	9,0 - 8,5	071 203	13,0 - 12,5	071 211	-	-
B 16	5,5 - 5,0	071 196	9,5 - 9,0	071 204	13,5 - 13,0	071 212	-	-
B 25	4,0 - 3,5	071 627	9,5 - 9,0	071 227	15,0 - 14,5	071 238	20,5 - 20,0	071 249
B 25	4,5 - 4,0	071 628	10,0 - 9,5	071 228	15,5 - 15,0	071 239	21,0 - 20,5	071 250
B 25	5,0 - 4,5	071 218	10,5 - 10,0	071 229	16,0 - 15,5	071 240	21,5 - 21,0	071 251
B 25	5,5 - 5,0	071 219	11,0 - 10,5	071 230	16,5 - 16,0	071 241	22,0 - 21,5	071 252
B 25	6,0 - 5,5	071 220	11,5 - 11,0	071 231	17,0 - 16,5	071 242	22,5 - 22,0	071 253
B 25	6,5 - 6,0	071 221	12,0 - 11,5	071 232	17,5 - 17,0	071 243	23,0 - 22,5	071 254
B 25	7,0 - 6,5	071 222	12,5 - 12,0	071 233	18,0 - 17,5	071 244	23,5 - 23,0	071 255
B 25	7,5 - 7,0	071 223	13,0 - 12,5	071 234	18,5 - 18,0	071 245	24,0 - 23,5	071 256
B 25	8,0 - 7,5	071 224	13,5 - 13,0	071 235	19,0 - 18,5	071 246	24,5 - 24,0	071 257
B 25	8,5 - 8,0	071 225	14,0 - 13,5	071 236	19,5 - 19,0	071 247	25,0 - 24,5	071 258
B 25	9,0 - 8,5	071 226	14,5 - 14,0	071 237	20,0 - 19,5	071 248	-	-
B 32	6,0 - 5,5	071 686	13,0 - 12,5	071 548	20,0 - 19,5	071 562	27,0 - 26,5	071 576
B 32	6,5 - 6,0	071 687	13,5 - 13,0	071 549	20,5 - 20,0	071 563	27,5 - 27,0	071 577
B 32	7,0 - 6,5	071 688	14,0 - 13,5	071 550	21,0 - 20,5	071 564	28,0 - 27,5	071 578
B 32	7,5 - 7,0	071 689	14,5 - 14,0	071 551	21,5 - 21,0	071 565	28,5 - 28,0	071 579
B 32	8,0 - 7,5	071 690	15,0 - 14,5	071 552	22,0 - 21,5	071 566	29,0 - 28,5	071 580
B 32	8,5 - 8,0	071 691	15,5 - 15,0	071 553	22,5 - 22,0	071 567	29,5 - 29,0	071 581
B 32	9,0 - 8,5	071 692	16,0 - 15,5	071 554	23,0 - 22,5	071 568	30,0 - 29,5	071 582
B 32	9,5 - 9,0	071 693	16,5 - 16,0	071 555	23,5 - 23,0	071 569	30,5 - 30,0	071 583
B 32	10,0 - 9,5	071 542	17,0 - 16,5	071 556	24,0 - 23,5	071 570	31,0 - 30,5	071 584
B 32	10,5 - 10,0	071 543	17,5 - 17,0	071 557	24,5 - 24,0	071 571	31,5 - 31,0	071 585
B 32	11,0 - 10,5	071 544	18,0 - 17,5	071 558	25,0 - 24,5	071 572	32,0 - 31,5	071 586
B 32	11,5 - 11,0	071 545	18,5 - 18,0	071 559	25,5 - 25,0	071 573	-	-
B 32	12,0 - 11,5	071 546	19,0 - 18,5	071 560	26,0 - 25,5	071 574	-	-
B 32	12,5 - 12,0	071 547	19,5 - 19,0	071 561	26,5 - 26,0	071 575	-	-

Spannmuttern für Spannzangenfutter
ab Seite H 10.13.

Clamping nuts for collet chucks,
from page H 10.13.

Ècrous pour mandrins:
voir accessoires, page H 10.13.

Zubehör/Ersatzteile für Spannzangenfutter

Accessories/Spare parts for collet chucks

Accessoires/Pièces de rechange pour mandrins porte-pinces

Spannzangen DIN 6388-A 1:10 für Fräser mit Anzugsgewinde System Clarkson

Collets DIN 6388-A 1:10 for milling cutters with pull thread system Clarkson

Pinces type DIN 6388-A 1:10 pour fraises avec tirant type Clarkson

Nenngröße <i>Nominal size</i> Dimension nominale	Einheits- Nummer <i>Standard No.</i> No standard	d_1	l_1	Spannbereich <i>Clamping range</i> Capacité de serrage A	Satz / Set / Jeu Best.-Nr. <i>Order No.</i> No de cde.
A 16	421 E	22,65	42	6 - 12	071 013
A 25	459 E	32,90	52	6 - 25	071 014
A 32	460 E	41,30	63	6 - 32	071 020

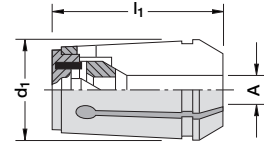

Zum Spannen dieser Spannzangen empfehlen wir Spannmuttern kugelgelagert für erhöhte Spannkraft.

To lock these collets, we recommend using the clamping nuts with ball-bearing for higher clamping forces.

Pour un serrage important, utiliser plutôt les écrous avec palier à billes.

Nenngröße <i>Nominal size</i> Dimension nominale	$\emptyset A$	Best.-Nr. <i>Order No.</i> No de cde.
A 16	6,0	071 304
A 16	8,0	071 305
A 16	10,0	071 306
A 16	12,0	071 307
A 25	6,0	071 308
A 25	8,0	071 309
A 25	10,0	071 310
A 25	12,0	071 311
A 25	16,0	071 312
A 25	20,0	071 313
A 25	25,0	071 684
A 32	6,0	071 427
A 32	8,0	071 428
A 32	10,0	071 429
A 32	12,0	071 430
A 32	16,0	071 431
A 32	20,0	071 432
A 32	25,0	071 433
A 32	32,0	071 685

Spannmuttern für Spannzangenfutter ab Seite H 10.13.

Clamping nuts for collet chucks, from page H 10.13.

Écrous pour mandrins: voir accessoires, page H 10.13.



H

Zubehör/Ersatzteile für Spannzangenfutter

Accessories/Spare parts for collet chucks

Accessoires/Pièces de rechange pour mandrins porte-pinces

Spannzangen DIN 6499-B 8°

Collets DIN 6499-B 8°

Pinces type DIN 6499-B 8°

Nenngröße <i>Nominal size</i> Dimension nominale	Einheits- Nummer <i>Standard-No.</i> No standard	d_1	l_1	Spannbereich <i>Clamping range</i> Capacité de serrage A	Satz / Set / Jeu Best.-Nr. <i>Order No.</i> No de cde.
ER 8	4004 E	8,5	13,5	1,0 - 5,0	071 034
ER 11	4008 E	11,5	18,0	1,0 - 7,0	071 028
ER 16	426 E	16	27,5	0,5 - 10,0	071 029
ER 25	430 E	25	34,0	1,0 - 16,0	071 031
ER 32	470 E	32	40,0	2,0 - 20,0	071 032
ER 40	472 E	40	46,0	3,0 - 26,0	071 033

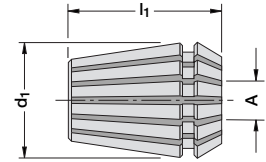

Nenngröße <i>Nominal size</i> Dimension nominale	Ø A von / bis <i>from / to</i> de / à	Bestell- Nummer <i>Order No.</i> No de cde.	Ø A von / bis <i>from / to</i> de / à	Bestell- Nummer <i>Order No.</i> No de cde.	Ø A von / bis <i>from / to</i> de / à	Bestell- Nummer <i>Order No.</i> No de cde.	Ø A von / bis <i>from / to</i> de / à	Bestell- Nummer <i>Order No.</i> No de cde.
ER 8	1,0	071 986	2,5	071 989	4,0 - 3,6	071 992	10,0 - 9,0	-
ER 8	1,5	071 987	3,0 - 2,6	071 990	4,5 - 4,1	071 993	-	-
ER 8	2,0	071 988	3,5 - 3,1	071 991	5,0 - 4,6	071 994	-	-
ER 11	1,0	071 700	3,0 - 2,6	071 704	5,0 - 4,6	071 708	7,0 - 6,6	071 712
ER 11	1,5	071 701	3,5 - 3,1	071 705	5,5 - 5,1	071 709	-	-
ER 11	2,0	071 702	4,0 - 3,6	071 706	6,0 - 5,6	071 710	-	-
ER 11	2,5	071 703	4,5 - 4,1	071 707	6,5 - 6,1	071 711	-	-
ER 16	1,0 - 0,5	071 713	4,0 - 3,0	071 719	7,0 - 6,0	071 722	10,0 - 9,0	071 725
ER 16	2,0 - 1,0	071 715	5,0 - 4,0	071 720	8,0 - 7,0	071 723	-	-
ER 16	3,0 - 2,0	071 717	6,0 - 5,0	071 721	9,0 - 8,0	071 724	-	-
ER 25	2,0 - 1,0	071 743	6,0 - 5,0	071 748	10,0 - 9,0	071 752	14,0 - 13,0	071 756
ER 25	3,0 - 2,0	071 745	7,0 - 6,0	071 749	11,0 - 10,0	071 753	15,0 - 14,0	071 757
ER 25	4,0 - 3,0	071 746	8,0 - 7,0	071 750	12,0 - 11,0	071 754	16,0 - 15,0	071 758
ER 25	5,0 - 4,0	071 747	9,0 - 8,0	071 751	13,0 - 12,0	071 755	-	-
ER 32	3,0 - 2,0	071 761	8,0 - 7,0	071 766	13,0 - 12,0	071 771	18,0 - 17,0	071 776
ER 32	4,0 - 3,0	071 762	9,0 - 8,0	071 767	14,0 - 13,0	071 772	19,0 - 18,0	071 777
ER 32	5,0 - 4,0	071 763	10,0 - 9,0	071 768	15,0 - 14,0	071 773	20,0 - 19,0	071 778
ER 32	6,0 - 5,0	071 764	11,0 - 10,0	071 769	16,0 - 15,0	071 774	-	-
ER 32	7,0 - 6,0	071 765	12,0 - 11,0	071 770	17,0 - 16,0	071 775	-	-
ER 40	4,0 - 3,0	071 779	10,0 - 9,0	071 785	16,0 - 15,0	071 791	22,0 - 21,0	071 797
ER 40	5,0 - 4,0	071 780	11,0 - 10,0	071 786	17,0 - 16,0	071 792	23,0 - 22,0	071 798
ER 40	6,0 - 5,0	071 781	12,0 - 11,0	071 787	18,0 - 17,0	071 793	24,0 - 23,0	071 799
ER 40	7,0 - 6,0	071 782	13,0 - 12,0	071 788	19,0 - 18,0	071 794	25,0 - 24,0	071 800
ER 40	8,0 - 7,0	071 783	14,0 - 13,0	071 789	20,0 - 19,0	071 795	26,0 - 25,0	071 801
ER 40	9,0 - 8,0	071 784	15,0 - 14,0	071 790	21,0 - 20,0	071 796	-	-

Spannmutter für Spannzangenfutter
ab Seite H 10.13.

Clamping nuts for collet chucks,
from page H 10.13.

Ècrous pour mandrins:
voir accessoires, page H 10.13.

Zubehör/Ersatzteile für Spannzangenfutter

Accessories/Spare parts for collet chucks

Accessoires/Pièces de rechange pour mandrins porte-pinces

Spannzangen DIN 6499-B 8° für
Gewindebohrer DIN 371/374/376

Collets DIN 6499-B 8° for taps
DIN 371/374/376

Pinces type DIN 6499-B 8° avec
carré entraînement pour tarauds
DIN 371/374/376

Nenngröße <i>Nominal size</i> Dimension nominale	Einheits- Nummer <i>Standard-No.</i> No standard	Spannbereich <i>Clamping range</i> Capacité de serrage A		Satz / Set / Jeu Best.-Nr. <i>Order No.</i> No de cde.
		d _i	l ₁	
ER 16	426 EGB	16	27,5	4,5 - 7 071 045
ER 25	430 EGB	25	34,0	4,5 - 12 071 047
ER 32	470 EGB	32	40,0	4,5 - 16 071 048
ER 40	472 EGB	40	46,0	7,0 - 20 071 049

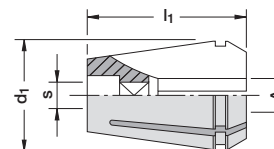

Zum Spannen dieser Spannzangen emp-
fehlen wir Spannmutter mit Gleitring für
erhöhte Spannkraft.

To lock these collets, we recommend using
the clamping nuts with sliding ring for higher
clamping forces.

Pour un serrage important, utiliser plutôt les
écrous avec anneau glissant.

Nenngröße <i>Nominal size</i> Dimension nominale	für Gewindebohrer <i>suitable taps</i> pour taraud		Best.-Nr. <i>Order No.</i> No de cde.	für Gewindebohrer <i>suitable taps</i> pour taraud		Best.-Nr. <i>Order No.</i> No de cde.
	Ø A	s □		Ø A	s □	
ER 16	4,5	3,4	071 901	6,0	4,9	071 903
ER 16	5,5	4,3	071 902	7,0	5,5	071 904
ER 25	4,5	3,4	071 912	9,0	7,0	071 917
ER 25	5,5	4,3	071 913	10,0	8,0	071 918
ER 25	6,0	4,9	071 914	11,0	9,0	071 919
ER 25	7,0	5,5	071 915	12,0	9,0	071 920
ER 25	8,0	6,2	071 916	-	-	-
ER 32	4,5	3,4	071 921	10,0	8,0	071 927
ER 32	5,5	4,3	071 922	11,0	9,0	071 928
ER 32	6,0	4,9	071 923	12,0	9,0	071 929
ER 32	7,0	5,5	071 924	14,0	11,0	071 930
ER 32	8,0	6,2	071 925	16,0	12,0	071 931
ER 32	9,0	7,0	071 926	-	-	-
ER 40	7,0	5,5	071 932	12,0	9,0	071 937
ER 40	8,0	6,2	071 933	14,0	11,0	071 938
ER 40	9,0	7,0	071 934	16,0	12,0	071 939
ER 40	10,0	8,0	071 935	18,0	14,5	071 940
ER 40	11,0	9,0	071 936	20,0	16,0	071 941

Schaftmaße <i>Shank dimensions</i> Diamètre de queue		Gewindebohrer <i>Taps</i> Taraud			Schaftmaße <i>Shank dimensions</i> Diamètre de queue		Gewindebohrer <i>Taps</i> Taraud		
Ø A	s □	DIN 371	DIN 374	DIN 376	Ø A	s □	DIN 371	DIN 374	DIN 376
4,5	3,4	M 4	M 6 x...	M 6	11	9,0	-	M 14 x...	M 14
5,5	4,3	-	M 7 x...	M 7	12	9,0	M 12	M 16 x...	M 16
6,0	4,9	M 4,5/5/6	M 8 x...	M 8	14	11,0	-	M 18 x...	M 18
7,0	5,5	M 7	M 9/10 x...	M 9/10	16	12,0	-	M 20 x...	M 20
8,0	6,2	M 8	M 6 x...	M 11	18	14,5	-	M 22/24 x...	M 22/24
9,0	7,0	M 9	M 6 x...	M 12	20	16,0	-	M 27 x...	M 27
10,0	8,0	M 10	-	-	-	-	-	-	-



Zubehör/Ersatzteile für Spannzangenfutter

Accessories/Spare parts for collet chucks

Accessoires/Pièces de rechange pour mandrins porte-pinces

**Spannzangen DIN 6499-B 8°
für Fräser mit Anzugsgewinde
System Clarkson**

*Collets DIN 6499-B 8° for milling
cutters with pull thread system
Clarkson*

Pinces type DIN 6499-B 8° pour
fraises type Clarkson

Nenngröße <i>Nominal size</i> Dimension nominale	Einheits- Nummer <i>Standard No.</i> No standard			Spannbereich <i>Clamping range</i> Capacité de serrage A	Satz / Set / Jeu Best.-Nr. <i>Order No.</i> No de cde.				
		d ₁	l ₁						
		ER 32	470 ECL			32	46	6 - 16	071 052
		ER 40	472 ECL			40	52	6 - 25	071 053

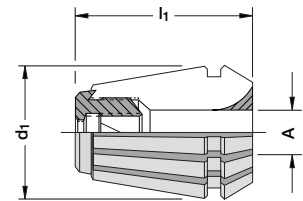

Zum Spannen dieser Spannzangen emp-
fehlen wir Spannmutter mit Gleitring für
erhöhte Spannkraft.

*To lock these collets, we recommend using
the clamping nuts with sliding ring for higher
clamping forces.*

Pour un serrage important, utiliser plutôt les
écrous avec anneau glissant.

Nenngröße <i>Nominal size</i> Dimension nominale	Ø A	Best.-Nr. <i>Order No.</i> No de cde.
ER 32	6,0	071 826
ER 32	8,0	071 827
ER 32	10,0	071 828
ER 32	12,0	071 829
ER 32	16,0	071 830
ER 40	6,0	071 831
ER 40	8,0	071 832
ER 40	10,0	071 833
ER 40	12,0	071 834
ER 40	16,0	071 835
ER 40	20,0	071 836
ER 40	25,0	071 837



H

Zubehör/Ersatzteile für Spannzangenfutter

Accessories/Spare parts for collet chucks

Accessoires/Pièces de rechange pour mandrins porte-pinces

Aufbewahrungskasten für
Spannzangen

Tool case for collets

Coffret pour pinces



Nenngröße <i>Nominal size</i> Dimension nominale	Breite <i>Width</i> Largeur	Tiefe <i>Depth</i> Profondeur	Höhe <i>Height</i> Hauteur	Spannzangenplätze <i>Space for collets</i> Nb. logements pour pinces	Best.-Nr. <i>Order No.</i> No de cde.
DIN 6499 8°					
ER 16	140	72	45	10	099 049
ER 25	196	112	50	15	099 050
ER 32	251	140	56	18	099 051
DIN 6388 1:10					
A/B 16	226	161	85	15	099 053
A/B 25	333	201	85	24	099 054
A/B 32	320	210	85	15	099 055



H

Zubehör/Ersatzteile für Spannzangenfutter

Accessories/Spare parts for collet chucks

Accessoires/Pièces de rechange pour mandrins porte-pinces

Kugelgelagerte Spannmutter DIN 6388 1:10

Clamping nuts DIN 6388 1:10
with ball-bearing

Écrous de serrage
type DIN 6388 1:10
avec palier à billes

Nenngröße Nominal size Dim. nominale	für Spannbereich for clamping range p. capacité de serrage		Anziehdrehmom. Torque Couple de serrage Nm	Best.-Nr. Order No. No de cde.
	d ₁	l ₁		
16	43	24,0	2,0 - 16	100 068 048
25	60	30,0	2,0 - 25	180 068 052
32	72	33,5	4,0 - 32	220 161 099

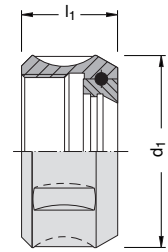

Kugelgelagerte Spannmutter DIN 6388 1:10, vorgefertigt zur Aufnahme von Dichtscheiben

Clamping nuts DIN 6388 1:10
with ball-bearing, for use with sealing discs

Écrous de serrage DIN 6388 1:10
avec palier à billes pour l'usage des disques
d'étanchéité

Nenngröße Nominal size Dim. nominale	für Spannbereich for clamping range p. capacité de serrage		Anziehdrehmom. Torque Couple de serrage Nm	Best.-Nr. Order No. No de cde.
	d ₁	l ₁		
16	43	31,5	2,0 - 16	100 275 001
25	60	38,0	2,0 - 25	180 275 003
32	72	42,0	4,0 - 32	220 276 001

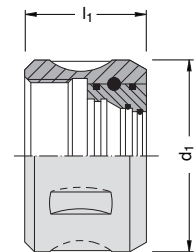

Spannmutter „Mini“

Clamping nuts "Mini"

Écrous de serrage "Mini"

Nenngröße Nominal size Dim. nominale	für Spannbereich for clamping range p. capacité de serrage		Anziehdrehmom. Torque Couple de serrage Nm	Best.-Nr. Order No. No de cde.
	d ₁	l ₁		
ER 8	12	10,8	1 - 4	8 415 357
ER 11	16	12,0	1 - 7	16 415 358
ER 16	22	18,0	1 - 10	25 415 359

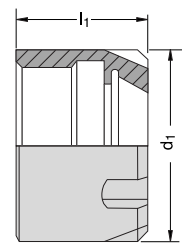

Spannmutter für Spann- zangenfutter System Erickson

Clamping nuts for collet chucks
system Erickson

Écrous pour mandrins type
Erickson

Nenngröße Nominal size Dimension nominale	für Spannbereich for clamping range pour capacité de serrage		Best.-Nr. Order No. No de cde.
	d ₁	l ₁	
6	14	28	1,0 - 6,5 162 095
10	21	36	1,0 - 10 162 093

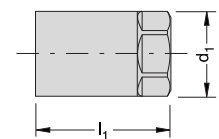

H

Zubehör/Ersatzteile für Spannzangenfutter

Accessories/Spare parts for collet chucks

Accessoires/Pièces de rechange pour mandrins porte-pinces

Einteilige Spannmutter DIN 6499 8°

One piece clamping nuts
DIN 6499 8°

Écrous de serrage d'une pièce
type DIN 6499 8°

Nenngröße <i>Nominal size</i> Dim. nominale	für Spannbereich <i>for clamping range</i> p. capacité de serrage		Anziehdrehmom. <i>Torque</i> Couple de serrage Nm	Best.-Nr. <i>Order No.</i> No de cde.	
	d ₁	l ₁			
	ER 16	28			17,5
ER 25	42	20,0	2 - 16	100	215 924
ER 32	50	22,5	2 - 20	140	215 925
ER 40	63	25,5	4 - 26	180	215 926

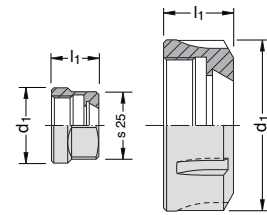

Spannmutter DIN 6499 8° mit Gleitring

Clamping nuts DIN 6499 8°
with sliding ring

Écrous de serrage type DIN 6499 8°
avec anneau glissant

Nenngröße <i>Nominal size</i> Dim. nominale	für Spannbereich <i>for clamping range</i> p. capacité de serrage		Anziehdrehmom. <i>Torque</i> Couple de serrage Nm	Best.-Nr. <i>Order No.</i> No de cde.	
	d ₁	l ₁			
	ER 16	28			20,3
ER 25	42	22,4	2 - 16	100	315 016
ER 32	50	25,0	2 - 20	140	315 017
ER 40	63	28,3	4 - 26	180	315 018

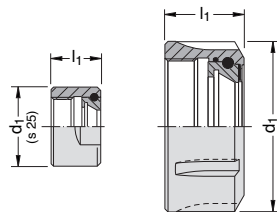

Einteilige Spannmutter DIN 6499 8° vorgefertigt zur Aufnahme von Dichtscheiben

One piece clamping nuts
DIN 6499 8°
for use with sealing discs

Écrous de serrage d'une pièce
type DIN 6499 8°
pour l'usage de disques d'étanchéité

Nenngröße <i>Nominal size</i> Dim. nominale	für Spannbereich <i>for clamping range</i> p. capacité de serrage		Anziehdrehmom. <i>Torque</i> Couple de serrage Nm	Best.-Nr. <i>Order No.</i> No de cde.	
	d ₁	l ₁			
	ER 16	28			25,0
ER 25	42	27,5	2 - 16	100	277 005
ER 32	50	30,5	2 - 20	140	277 007
ER 40	63	34,0	4 - 26	180	278 001

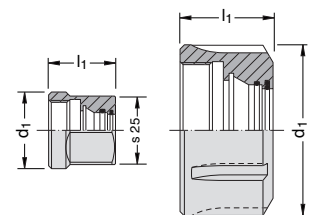

Spannmutter DIN 6499 8° mit Gleitring, vorgefertigt zur Aufnahme von Dichtscheiben

Clamping nuts DIN 6499 8°
with sliding ring, for use with sealing discs

Écrous de serrage type DIN 6499 8°
avec anneau glissant, pour l'usage de
disques d'étanchéité

Nenngröße <i>Nominal size</i> Dim. nominale	für Spannbereich <i>for clamping range</i> p. capacité de serrage		Anziehdrehmom. <i>Torque</i> Couple de serrage Nm	Best.-Nr. <i>Order No.</i> No de cde.	
	d ₁	l ₁			
	ER 16	28			25,0
ER 25	42	28,5	2 - 16	100	277 006
ER 32	50	31,5	2 - 20	140	277 008
ER 40	63	35,0	4 - 26	180	278 002

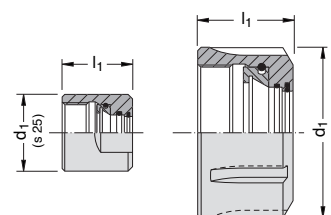

H

Zubehör/Ersatzteile für Spannzangenfutter

Accessories/Spare parts for collet chucks

Accessoires/Pièces de rechange pour mandrins porte-pinces

Dichtscheiben DIN 6388 1:10
zum Einsatz in kugelgelagerte
Spannmuttern.

Sealing discs DIN 6388 1:10
for use in clamping nuts with ball-bearing.

Disques d'étanchéité
type DIN 6388 1:10
pour l'usage dans les écrous de serrage
avec palier à billes.

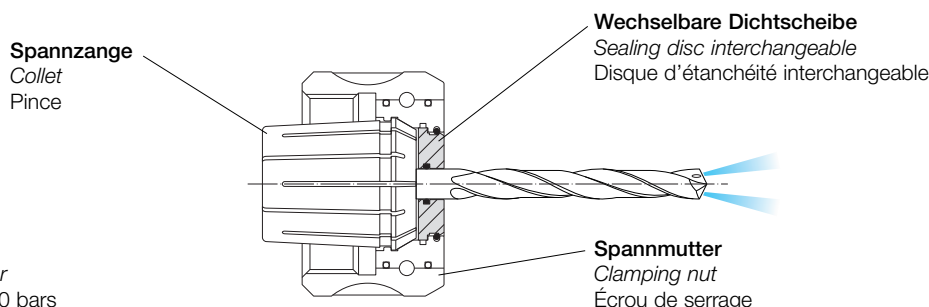

Für Drücke bis 80 bar
For pressure up to 80 bar
Pour pressions jusqu'à 80 bars

Nenngröße Nominal size Dimension nominale	Ø A von / bis from / to de / à	Bestell- Nummer Order No. No de cde.	Ø A von / bis from / to de / à	Bestell- Nummer Order No. No de cde.	Ø A von / bis from / to de / à	Bestell- Nummer Order No. No de cde.	Ø A von / bis from / to de / à	Bestell- Nummer Order No. No de cde.
16	3,0 - 2,5	275 010	6,5 - 6,0	275 017	10,0 - 9,5	275 024	13,5 - 13,0	275 031
16	3,5 - 3,0	275 011	7,0 - 6,5	275 018	10,5 - 10,0	275 025	14,0 - 13,5	275 032
16	4,0 - 3,5	275 012	7,5 - 7,0	275 019	11,0 - 10,5	275 026	14,5 - 14,0	275 033
16	4,5 - 4,0	275 013	8,0 - 7,5	275 020	11,5 - 11,0	275 027	15,0 - 14,5	275 034
16	5,0 - 4,5	275 014	8,5 - 8,0	275 021	12,0 - 11,5	275 028	15,5 - 15,0	275 035
16	5,5 - 5,0	275 015	9,0 - 8,5	275 022	12,5 - 12,0	275 029	16,0 - 15,5	275 036
16	6,0 - 5,5	275 016	9,5 - 9,0	275 023	13,0 - 12,5	275 030	-	-
25	3,0 - 2,5	275 040	9,0 - 8,5	275 052	15,0 - 14,5	275 064	21,0 - 20,5	275 076
25	3,5 - 3,0	275 041	9,5 - 9,0	275 053	15,5 - 15,0	275 065	21,5 - 21,0	275 077
25	4,0 - 3,5	275 042	10,0 - 9,5	275 054	16,0 - 15,5	275 066	22,0 - 21,5	275 078
25	4,5 - 4,0	275 043	10,5 - 10,0	275 055	16,5 - 16,0	275 067	22,5 - 22,0	275 079
25	5,0 - 4,5	275 044	11,0 - 10,5	275 056	17,0 - 16,5	275 068	23,0 - 22,5	275 080
25	5,5 - 5,0	275 045	11,5 - 11,0	275 057	17,5 - 17,0	275 069	23,5 - 23,0	275 081
25	6,0 - 5,5	275 046	12,0 - 11,5	275 058	18,0 - 17,5	275 070	24,0 - 23,5	275 082
25	6,5 - 6,0	275 047	12,5 - 12,0	275 059	18,5 - 18,0	275 071	24,5 - 24,0	275 083
25	7,0 - 6,5	275 048	13,0 - 12,5	275 060	19,0 - 18,5	275 072	25,0 - 24,5	275 084
25	7,5 - 7,0	275 049	13,5 - 13,0	275 061	19,5 - 19,0	275 073	-	-
25	8,0 - 7,5	275 050	14,0 - 13,5	275 062	20,0 - 19,5	275 074	-	-
25	8,5 - 8,0	275 051	14,5 - 14,0	275 063	20,5 - 20,0	275 075	-	-
32	4,0 - 3,5	276 005	11,5 - 11,0	276 020	19,0 - 18,5	276 035	26,5 - 26,0	276 050
32	4,5 - 4,0	276 006	12,0 - 11,5	276 021	19,5 - 19,0	276 036	27,0 - 26,5	276 051
32	5,0 - 4,5	276 007	12,5 - 12,0	276 022	20,0 - 19,5	276 037	27,5 - 27,0	276 052
32	5,5 - 5,0	276 008	13,0 - 12,5	276 023	20,5 - 20,0	276 038	28,0 - 27,5	276 053
32	6,0 - 5,5	276 009	13,5 - 13,0	276 024	21,0 - 20,5	276 039	28,5 - 28,0	276 054
32	6,5 - 6,0	276 010	14,0 - 13,5	276 025	21,5 - 21,0	276 040	29,0 - 28,5	276 055
32	7,0 - 6,5	276 011	14,5 - 14,0	276 026	22,0 - 21,5	276 041	29,5 - 29,0	276 056
32	7,5 - 7,0	276 012	15,0 - 14,5	276 027	22,5 - 22,0	276 042	30,0 - 29,5	276 057
32	8,0 - 7,5	276 013	15,5 - 15,0	276 028	23,0 - 22,5	276 043	30,5 - 30,0	276 058
32	8,5 - 8,0	276 014	16,0 - 15,5	276 029	23,5 - 23,0	276 044	31,0 - 30,5	276 059
32	9,0 - 8,5	276 015	16,5 - 16,0	276 030	24,0 - 23,5	276 045	31,5 - 31,0	276 060
32	9,5 - 9,0	276 016	17,0 - 16,5	276 031	24,5 - 24,0	276 046	32,0 - 31,5	276 061
32	10,0 - 9,5	276 017	17,5 - 17,0	276 032	25,0 - 24,5	276 047	-	-
32	10,5 - 10,0	276 018	18,0 - 17,5	276 033	25,5 - 25,0	276 048	-	-
32	11,0 - 10,5	276 019	18,5 - 18,0	276 034	26,0 - 25,5	276 049	-	-

Zubehör/Ersatzteile für Spannzangenfutter

Accessories/Spare parts for collet chucks

Accessoires/Pièces de rechange pour mandrins porte-pinces

Dichtscheiben DIN 6499 8°

zum Einsatz in einteilige Spannmuttern
oder mit Gleitring.

Sealing discs DIN 6499 8°

for use either with one piece clamping nuts
or with sliding ring.

Disques d'étanchéité type DIN 6499 8°

pour écrous de serrage monobloc et écrous
de serrage avec anneau glissant.

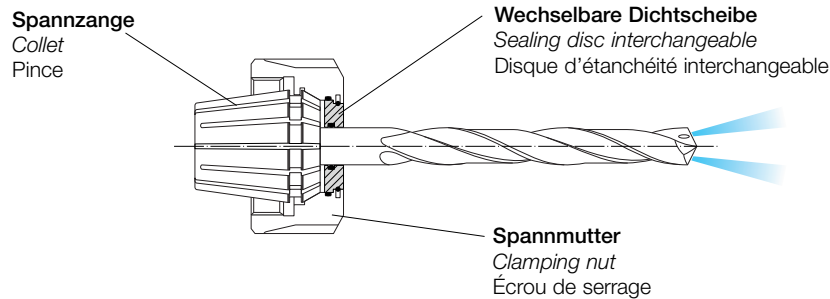

Für Drücke bis 80 bar

For pressure up to 80 bar

Pour pressions jusqu'à 80 bars

Nenngröße Nominal size Dimension nominale	Ø A von / bis from / to de / à	Bestell- Nummer Order No. No de cde.	Ø A von / bis from / to de / à	Bestell- Nummer Order No. No de cde.	Ø A von / bis from / to de / à	Bestell- Nummer Order No. No de cde.	Ø A von / bis from / to de / à	Bestell- Nummer Order No. No de cde.
ER 16	3,0 - 2,5	277 010	5,0 - 4,5	277 014	7,0 - 6,5	277 018	9,0 - 8,5	277 022
ER 16	3,5 - 3,0	277 011	5,5 - 5,0	277 015	7,5 - 7,0	277 019	9,5 - 9,0	277 023
ER 16	4,0 - 3,5	277 012	6,0 - 5,5	277 016	8,0 - 7,5	277 020	10,0 - 9,5	277 024
ER 16	4,5 - 4,0	277 013	6,5 - 6,0	277 017	8,5 - 8,0	277 021	-	-
ER 25	3,0 - 2,5	277 025	6,5 - 6,0	277 032	10,0 - 9,5	277 039	13,5 - 13,0	277 046
ER 25	3,5 - 3,0	277 026	7,0 - 6,5	277 033	10,5 - 10,0	277 040	14,0 - 13,5	277 047
ER 25	4,0 - 3,5	277 027	7,5 - 7,0	277 034	11,0 - 10,5	277 041	14,5 - 14,0	277 048
ER 25	4,5 - 4,0	277 028	8,0 - 7,5	277 035	11,5 - 11,0	277 042	15,0 - 14,5	277 049
ER 25	5,0 - 4,5	277 029	8,5 - 8,0	277 036	12,0 - 11,5	277 043	15,5 - 15,0	277 050
ER 25	5,5 - 5,0	277 030	9,0 - 8,5	277 037	12,5 - 12,0	277 044	16,0 - 15,5	277 051
ER 25	6,0 - 5,5	277 031	9,5 - 9,0	277 038	13,0 - 12,5	277 045	-	-
ER 32	3,0 - 2,5	277 055	7,5 - 7,0	277 064	12,0 - 11,5	277 073	16,5 - 16,0	277 082
ER 32	3,5 - 3,0	277 056	8,0 - 7,5	277 065	12,5 - 12,0	277 074	17,0 - 16,5	277 083
ER 32	4,0 - 3,5	277 057	8,5 - 8,0	277 066	13,0 - 12,5	277 075	17,5 - 17,0	277 084
ER 32	4,5 - 4,0	277 058	9,0 - 8,5	277 067	13,5 - 13,0	277 076	18,0 - 17,5	277 085
ER 32	5,0 - 4,5	277 059	9,5 - 9,0	277 068	14,0 - 13,5	277 077	18,5 - 18,0	277 086
ER 32	5,5 - 5,0	277 060	10,0 - 9,5	277 069	14,5 - 14,0	277 078	19,0 - 18,5	277 087
ER 32	6,0 - 5,5	277 061	10,5 - 10,0	277 070	15,0 - 14,5	277 079	19,5 - 19,0	277 088
ER 32	6,5 - 6,0	277 062	11,0 - 10,5	277 071	15,5 - 15,0	277 080	20,0 - 19,5	277 089
ER 32	7,0 - 6,5	277 063	11,5 - 11,0	277 072	16,0 - 15,5	277 081	-	-
ER 40	3,0 - 2,5	278 005	9,0 - 8,5	278 017	15,0 - 14,5	278 029	21,0 - 20,5	278 041
ER 40	3,5 - 3,0	278 006	9,5 - 9,0	278 018	15,5 - 15,0	278 030	21,5 - 21,0	278 042
ER 40	4,0 - 3,5	278 007	10,0 - 9,5	278 019	16,0 - 15,5	278 031	22,0 - 21,5	278 043
ER 40	4,5 - 4,0	278 008	10,5 - 10,0	278 020	16,5 - 16,0	278 032	22,5 - 22,0	278 044
ER 40	5,0 - 4,5	278 009	11,0 - 10,5	278 021	17,0 - 16,5	278 033	23,0 - 22,5	278 045
ER 40	5,5 - 5,0	278 010	11,5 - 11,0	278 022	17,5 - 17,0	278 034	23,5 - 23,0	278 046
ER 40	6,0 - 5,5	278 011	12,0 - 11,5	278 023	18,0 - 17,5	278 035	24,0 - 23,5	278 047
ER 40	6,5 - 6,0	278 012	12,5 - 12,0	278 024	18,5 - 18,0	278 036	24,5 - 24,0	278 048
ER 40	7,0 - 6,5	278 013	13,0 - 12,5	278 025	19,0 - 18,5	278 037	25,0 - 24,5	278 049
ER 40	7,5 - 7,0	278 014	13,5 - 13,0	278 026	19,5 - 19,0	278 038	25,5 - 25,0	278 050
ER 40	8,0 - 7,5	278 015	14,0 - 13,5	278 027	20,0 - 19,5	278 039	26,0 - 25,5	278 051
ER 40	8,5 - 8,0	278 016	14,5 - 14,0	278 028	20,5 - 20,0	278 040	-	-



Zubehör/Ersatzteile für Fräser- und Aufnahmedorne

Accessories/Spare parts for milling and holding arbors

Accessoires/Pièces de rechange pour mandrins porte-fraises et mandrins

Fräserdorner

Milling machine arbors

Mandrins porte-fraises

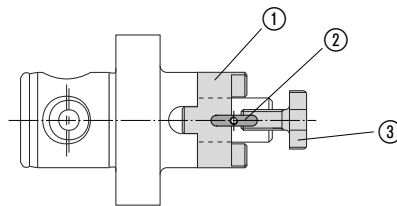

Fräseraufnahme Shell-mill adaptor Ø alésage fraise	Mitnehmerring ① Clutch drive ring Bague d'entraînement Best.-Nr. Order No. No de cde.	Passfeder ② Feather key Clavettes Best.-Nr. Order No. No de cde.	Fräseranzugsschraube ③ Cutter retaining screw Vis de serrage de la fraise Best.-Nr. Order No. No de cde.
13	115 708	115 709	115 707
16	115 696	215 608	115 697
22	115 341	215 609	115 345
27	115 342	215 610	115 346
32	115 343	215 611	115 347
40	115 344	215 612	115 348

Aufnahmedorner

Holding arbors

Mandrins

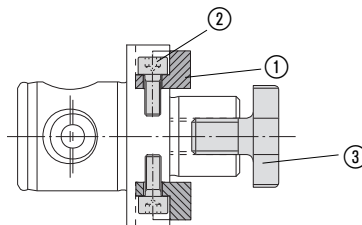

Fräseraufnahme Shell-mill adaptor Ø alésage fraise	Mitnehmer ① Torque bush Tenon d'entraînement Best.-Nr. Order No. No de cde.	Zylinderschraube ② Cap screw Vis à tête cylindrique Best.-Nr. Order No. No de cde.	Schlüssel Key size Clé	Fräseranzugsschraube ③ Cutter retaining screw Vis de serrage de la fraise Best.-Nr. Order No. No de cde.
16	215 701	115 566	s3 / B	115 697
22	215 702	108 109	s4 / B	115 345
27	215 703	108 109	s4 / B	115 346
32	215 704	115 147	s5 / B	115 347
40	215 705	116 152	s5 / B	115 348
60	115 643	115 237	s5 / B	-

Zubehör/Ersatzteile für Zwischenhülsen und Hydraulik-Dehnspannfutter

Accessories/Spare parts for adaptor sleeves and hydraulic clamping chucks

Accessoires/Pièces de rechange pour réduction et mandrins de serrage hydraulique

**Zwischenhülsen
für Morsekegelschäfte**

*Adaptor sleeves
for morse taper shanks*

Réductions
pour queues cônes Morse

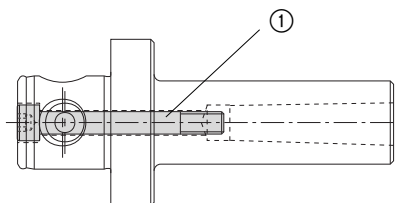

Zwischenhülsen <i>Adaptor sleeves</i> Réduction	Zylinderschraube ① <i>Cap screw</i> Vis à tête cylindrique	Schlüsselweite <i>Key size</i> Dim. de la clé
Best.-Nr. <i>Order No.</i> No de cde.	Best.-Nr. <i>Order No.</i> No de cde.	
209 022	115 929	s5
209 023	115 930	s7
209 024	115 932	s8
209 025	115 933	s5
209 026	115 169	s8
209 027	115 934	s10
209 028	115 936	s12

**Reduzierbuchsen
für Hydraulik-Dehnspannfutter**

*Reduction sleeves
for hydraulic clamping chucks*

Reductions pour
mandrins de serrage hydraulique

Für Zylinderschäfte
- mit Schafttoleranz h_6 für
Spanndurchmesser 3 und 8 mm
- mit Schafttoleranz h_7 für
Spanndurchmesser 10.....32 mm

For cylindrical shanks
- with shank tolerance h_6 for
clamping dia. 3 and 8 mm
- with shank tolerance h_7 for
clamping dia. 10.....32 mm

Pour cônes cylindriques
- avec tolérance du cône h_6 pour
diamètre de serrage 3 et 8 mm
- avec tolérance du cône h_7 pour
diamètre de serrage de 10 à 32 mm

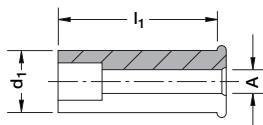

Nenngröße <i>Nominal size</i>				Nenngröße <i>Nominal size</i>				Nenngröße <i>Nominal size</i>			
Dimension nominale			Best.-Nr. <i>Order No.</i>	Dimension nominale			Best.-Nr. <i>Order No.</i>	Dimension nominale			Best.-Nr. <i>Order No.</i>
d_1	$\emptyset A$	l_1	No de cde.	d_1	$\emptyset A$	l_1	No de cde.	d_1	$\emptyset A$	l_1	No de cde.
20	3	50,5	271 045	20	8	50,5	271 004	20	13	50,5	271 052
20	4	50,5	271 046	20	9	50,5	271 050	20	14	50,5	271 007
20	5	50,5	271 047	20	10	50,5	271 005	20	15	50,5	271 018
20	6	50,5	271 003	20	11	50,5	271 051	20	16	50,5	271 008
20	7	50,5	271 049	20	12	50,5	271 006	20	17	50,5	271 053



Zubehör/Ersatzteile für Gewindeschneidfutter

Accessories/Spare parts for tapping chucks

Accessoires/Pièces de rechange pour mandrins de taraudage

Reduzierungen für Schnellwechsel-Einsätze

Reducers for quick-change adaptors

Réductions pour adaptateurs à changement rapide

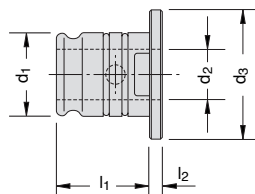
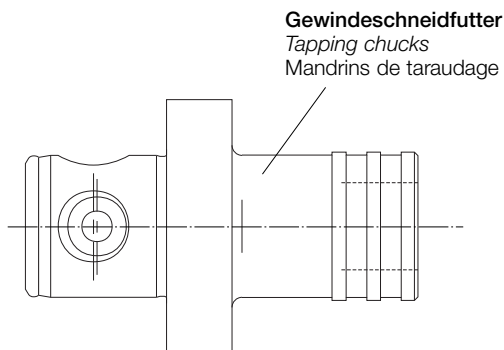

Schnellwechsel-Einsätze
Quick-change adaptors
Adaptateurs à changement rapide

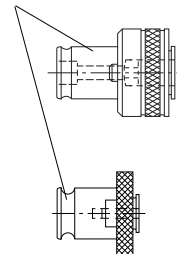

Gewindeschneidfutter Tapping chuck Mandrin de taraudage		Schnellwechsel-Einsatz Quick-change adaptor Adaptateur à changement rapide		Reduzierung Reducer Réduction						Best.-Nr. Order No. No de cde.
Nenngröße Nominal size Dimension nominale		Nenngröße Nominal size Dimension nominale		d ₁	d ₂	d ₃	l ₁	l ₂	kg	
1	d ₁ 19	0	d ₁ 13	19	13	30	21,5	4	0,12	161 038
2	d ₁ 31	1	d ₁ 19	31	19	48	35,0	5	0,48	162 094

Schnellwechsel-Einsätze

Im Regelfall sind die Schnellwechsel-Einsätze auf das angegebene Drehmoment eingestellt.

Quick-change adaptors

Usually, the quick-change adaptors are set to the torque shown in the table.

Adaptateurs à changement rapide

Les adaptateurs sont réglés aux valeurs de couple indiquées sur le tableau ci-dessous.

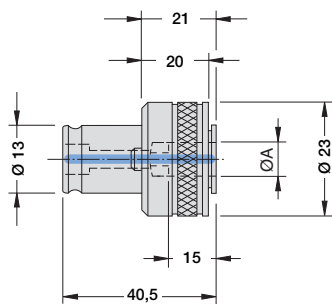

① mit Sicherheitskupplung
with safety connection
avec accouplement à segments extensibles

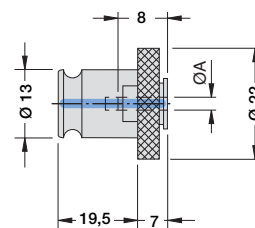

② ohne Sicherheitskupplung
without safety connection
sans accouplement à segments extensibles

Nenngröße Nominal size Dimension nominale	Schaftmaße Shank dimensions Diamètre		Eingestelltes Drehmoment Torque setting Couple pré-réglé							①	②
	de queue Ø A x □	DIN	DIN	DIN	DIN	DIN	DIN	DIN	Nm	Best.-Nr. Order No. No de cde.	Best.-Nr. Order No. No de cde.
0	2,5 x 2,1	M 1	—	M 1	—	M 3,5	1/16"	—	1,5 - 2	233 070	K 24 358
0	2,8 x 2,1	M 2	—	M 2	M 4	M 4	3/32"	5/32"	2 - 3	233 071	K 24 276
0	3,5 x 2,7	M 3	—	M 3	M 5	M 5	1/8"	—	4 - 6	233 072	K 24 277
0	4,0 x 3,0	M 3,5	—	M 3,5	—	—	—	—	1,5 - 2	233 073	K 24 278
0	4,5 x 3,4	M 4	—	M 4	M 6	M 6	5/32"	1/4"	6 - 9	233 074	K 24 279
0	6,0 x 4,9	M 8	—	—	M 8	M 8	—	—	16 - 21	233 075	K 24 280
0	7,0 x 5,5	M 10	G 1/8"	—	M 10	M 10	1/4"	3/8"	27 - 32	233 076	K 24 281
0	8,0 x 6,2	—	—	M 8	—	—	5/16"	7/16"	16 - 21	233 077	K 24 391

Zubehör/Ersatzteile für Gewindeschneidfutter

Accessories/Spare parts for tapping chucks

Accessoires/Pièces de rechange pour mandrins de taraudage

Schnellwechsel-Einsätze

Quick-change adaptors

Adaptateurs à changement rapide

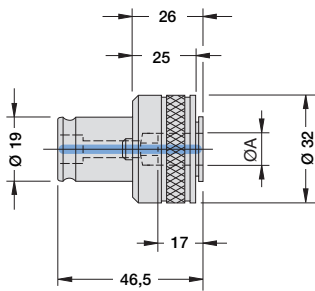

① mit Sicherheitskupplung
with safety connection
avec accouplement à segments
extensibles

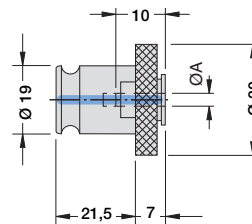

② ohne Sicherheitskupplung
without safety connection
sans accouplement à segments
extensibles

Nenngröße Nominal size	Schaftmaße Shank dimensions		Eingestelltes Drehmoment							①	②	
	Dimension de queue	Diamètre	Torque setting									Best.-Nr.
Dimension nominale	Ø A x □	Diamètre	DIN	DIN	DIN	DIN	DIN	DIN	DIN	Couple pré réglé	Order No.	Order No.
			352	353	371	374	376	2182	2183	Nm	No de cde.	No de cde.
1	2,8 x 2,1	M 2	–	M 2,8	M 4	M 4	3/32"	5/32"	–	2 - 3	K 17 847	K 23 259
1	3,5 x 2,7	M 3	–	M 3,5	M 5	M 5	1/8"	–	–	4 - 6	233 001	K 18 455
1	4,0 x 3,0	M 3,5	–	M 3,5	–	–	–	–	–	1,5 - 2	233 002	K 22 439
1	4,5 x 3,4	M 4	–	M 4	M 6	M 6	5/32"	1/4"	–	6 - 9	233 003	K 16 414
1	6,0 x 4,9	M 8	–	–	M 8	M 8	–	–	–	16 - 21	233 004	K 16 415
1	7,0 x 5,5	M 10	G 1/8"	–	M 10	M 10	1/4"	3/8"	–	27 - 32	233 005	K 16 418
1	8,0 x 6,2	–	–	M 8	–	–	5/16"	7/16"	–	16 - 21	233 006	K 16 416
1	9,0 x 7,0	M 12	–	–	M 12	M 12	3/8"	1/2"	–	37 - 44	233 007	K 18 454
1	10,0 x 8,0	–	–	M 10	–	–	–	–	–	27 - 32	233 008	K 16 417
1	11,0 x 9,0	M 14	G 1/4"	–	M 14	M 14	–	9/16"	–	50 - 53	233 009	K 22 440

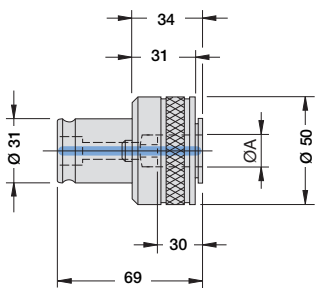

① mit Sicherheitskupplung
with safety connection
avec accouplement à segments
extensibles

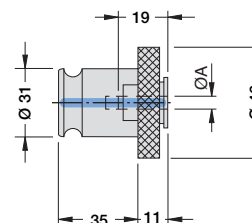

② ohne Sicherheitskupplung
without safety connection
sans accouplement à segments
extensibles

Nenngröße Nominal size	Schaftmaße Shank dimensions		Eingestelltes Drehmoment							①	②	
	Dimension de queue	Diamètre	Torque setting									Best.-Nr.
Dimension nominale	Ø A x □	Diamètre	DIN	DIN	DIN	DIN	DIN	DIN	DIN	Couple pré réglé	Order No.	Order No.
			352	353	371	374	376	2182	2183	Nm	No de cde.	No de cde.
2	7,0 x 5,5	M 10	G 1/8"	–	M 10	M 10	1/4"	3/8"	–	27 - 32	233 020	K 15 282
2	8,0 x 6,2	–	–	M 8	–	–	5/16"	7/16"	–	16 - 21	233 021	K 15 283
2	9,0 x 7,0	M 12	–	–	M 12	M 12	3/8"	1/2"	–	37 - 44	233 022	K 15 284
2	10,0 x 8,0	–	–	M 10	–	–	–	–	–	27 - 32	233 023	K 18 456
2	11,0 x 9,0	M 14	G 1/4"	–	M 14	M 14	–	9/16"	–	50 - 53	233 024	K 16 419
2	12,0 x 9,0	M 16	G 3/8"	–	M 16	M 16	–	5/8"	–	55 - 58	233 025	K 15 285
2	14,0 x 11,0	M 18	–	–	M 18	M 18	–	11/16"	–	85 - 90	233 026	K 16 420
2	16,0 x 12,0	M 20	G 1/2"	–	M 20	M 20	–	13/16"	–	110 - 115	233 027	K 15 286
2	18,0 x 14,5	M 24	–	–	M 24	M 24	–	15/16"	–	110 - 115	233 028	K 18 457



Zubehör/Ersatzteile für Gewindeschneidfutter

Accessories/Spare parts for tapping chucks

Accessoires/Pièces de rechange pour mandrins de taraudage

Schnellwechsel-Einsätze

Quick-change adaptors

Adaptateurs à changement rapide

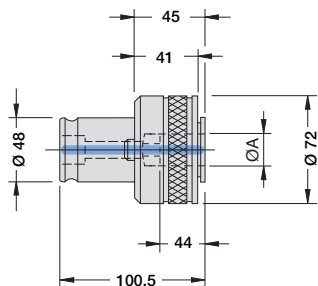

① mit Sicherheitskupplung
with safety connection
avec accouplement à
segments extensibles

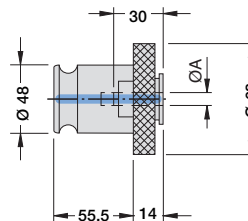

② ohne Sicherheitskupplung
without safety connection
sans accouplement à
segments extensibles

Nenngröße Nominal size	Schaftmaße Shank dimensions Diamètre de queue Ø A x □	Eingestelltes Drehmoment Torque setting Couple pré réglé							①	②	
		DIN 352	DIN 353	DIN 371	DIN 374	DIN 376	DIN 2182	DIN 2183	Best.-Nr. Order No. No de cde.	Best.-Nr. Order No. No de cde.	
3	11,0 x 9,0	M 14	G 1/4"	–	M 14	M 14	–	9/16"	50 - 53	233 040	K 22 434
3	12,0 x 9,0	M 16	G 3/8"	–	M 16	M 16	–	5/8"	55 - 58	233 041	K 22 435
3	14,0 x 11,0	M 18	–	–	M 18	M 18	–	11/16"	85 - 90	233 042	K 22 436
3	16,0 x 12,0	M 20	G 1/2"	–	M 20	M 20	–	13/16"	100 - 106	233 043	K 22 437
3	18,0 x 14,5	M 24	–	–	M 24	M 24	–	15/16"	140 - 150	233 044	K 16 421
3	20,0 x 16,0	M 27	G 3/4"	–	M 27	M 27	–	1"	150 - 160	233 045	K 16 422
3	22,0 x 18,0	M 30	G 7/8"	–	M 30	M 30	–	1 1/8"	240 - 250	233 046	K 16 423
3	25,0 x 20,0	M 33	G 1"	–	M 33	M 33	–	1 1/4"	260 - 270	233 047	K 16 424
3	28,0 x 22,0	M 36	G 1 1/8"	–	M 36	M 36	–	1 3/8"	260 - 270	233 048	K 22 438



H

Zubehör/Ersatzteile

Accessories/Spare parts

Accessoires/Pièces de rechange

Bedienungsschlüssel

Service keys

Clés de service

Für Spannzangenfutter mit Spannzangen System Erickson

For collet chucks with collets system Erickson

Pour mandrins porte-pinces type Erickson

Schlüsselweite Key size Dim. de la clé	Type	Best.-Nr. Order No. No de cde.
13,0	P	315 689
19,0	P	315 691

Type P



Für Spannzangenfutter 1:10

For collet chucks 1:10

Pour mandrins porte-pinces 1:10

Nenngröße Nominal size Dim. nominale	Größe Size Dimension	Schlüsselweite Key size Dim. de la clé	Type	Best.-Nr. Order No. No de cde.
16	40 - 43	–	S	068 179
16	–	5,0	B	115 577
25	58 - 62	–	S	068 182
25	–	6,0	B	115 578
32	68 - 75	–	S	115 867
32	–	6,0	B	115 578

Type S

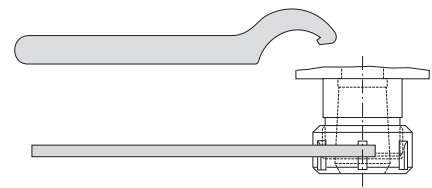

Type B

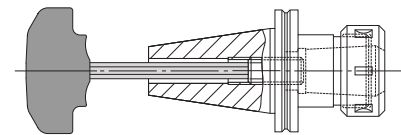

Für Spannzangenfutter 8°

For collet chucks 8°

Pour mandrins porte-pinces 8°

Nenngröße Nominal size Dim. nominale	Größe d Size Dimension	Schlüsselweite Key size Dim. de la clé	Type	Best.-Nr. Order No. No de cde.
ER 08 Mini	9,0	–	X	415 373
ER 11 Mini	12,0	–	X	415 374
ER 16 Mini	17,5	–	X	415 375
ER 16	–	25,0	P	215 927
ER 16	–	5,0	B	115 577
ER 25	42	–	T	215 929
ER 25	–	6,0	B	115 578
ER 32	50	–	T	215 930
ER 32	–	6,0	B	115 578
ER 40	63	–	T	215 931
ER 40	–	10,0	B	115 580

Type P



Type T

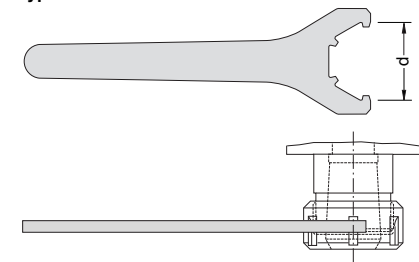

Type B

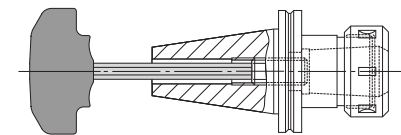

Type X für Spannmutter „Mini“
for clamping nut „Mini“
pour écrou de serrage „Mini“

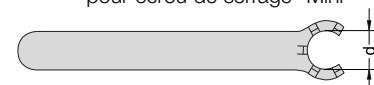

Zubehör/Ersatzteile

Accessories/Spare parts

Accessoires/Pièces de rechange

Bedienungsschlüssel

Service keys

Clés de service

Für Fräser- und Aufnahmedorne

For milling machine and holding arbors

Pour mandrins porte-fraises et mandrins

Fräseraufnahme <i>Shell-mill adaptor</i> Ø alésage fraise	Größe <i>Size</i> Dimension	Best.-Nr. <i>Order No.</i> No de cde.
13	13	115 785
16	16	115 699
22	22	115 660
27	27	115 661
32	32	115 662
40	40	115 663
60	60	315 637

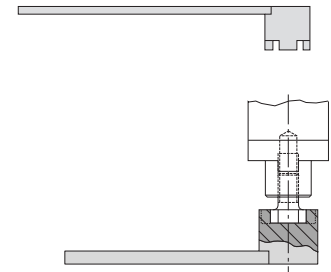

H